

DOWNTOWN BERKELEY BART PLAZA AND TRANSIT AREA
IMPROVEMENT PROJECT- 65% DESIGN ILLUSTRATIONS

PROJECT SITE PLAN

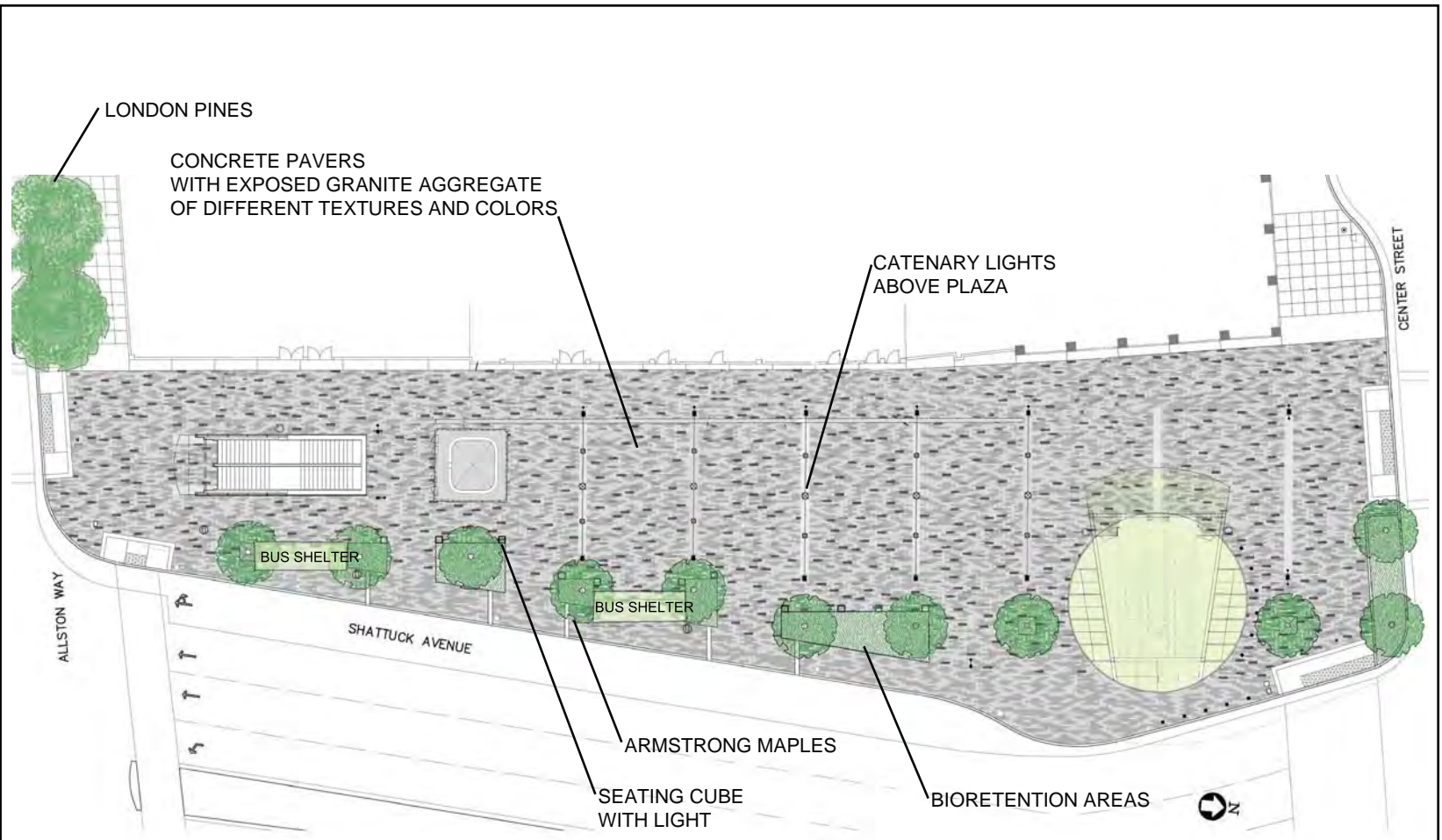

DOWNTOWN BERKELEY BART PLAZA AND TRANSIT AREA
IMPROVEMENT PROJECT- 65% DESIGN ILLUSTRATIONS

PLAZA LANDSCAPE PLAN

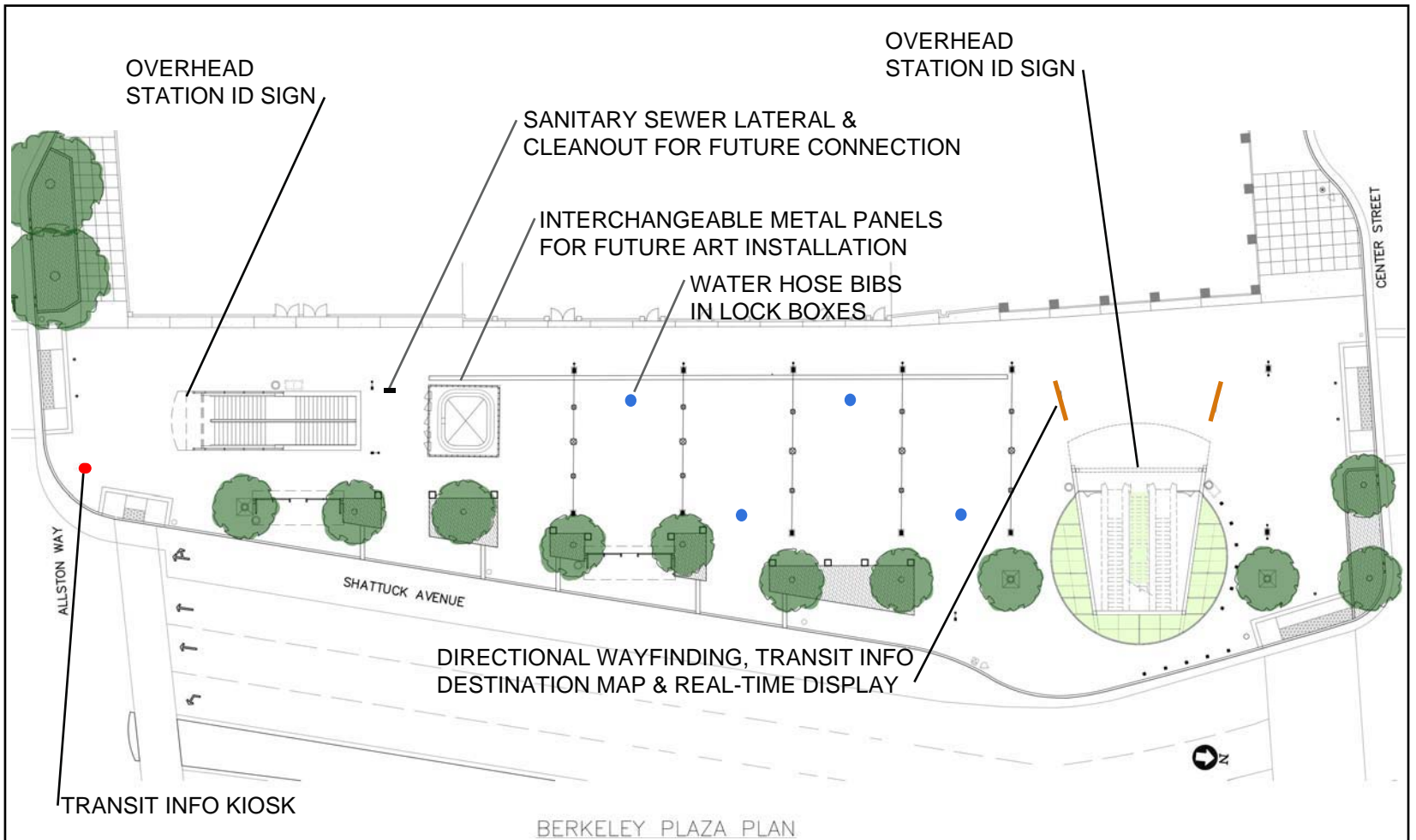

DOWNTOWN BERKELEY BART PLAZA AND TRANSIT AREA
IMPROVEMENT PROJECT- 65% DESIGN ILLUSTRATIONS

PLAZA SITE PLAN
WAYFINDING, UTILITY STUBOUTS
AND FUTURE ART ELEMENTS

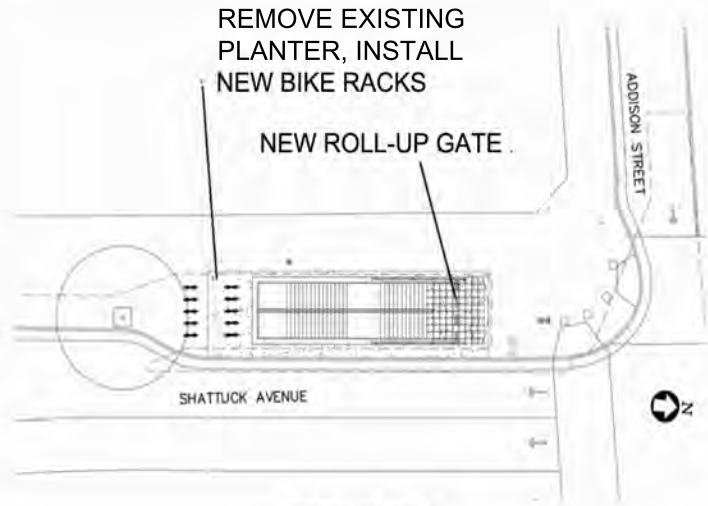

ENTRANCE AREA 5

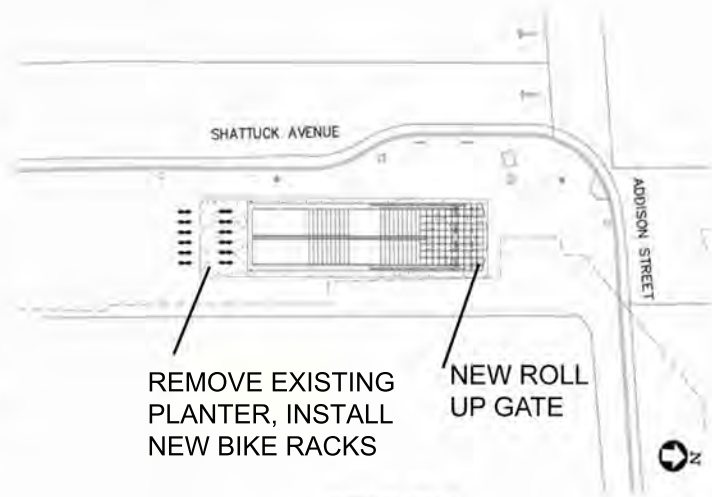

ENTRANCE AREA 6

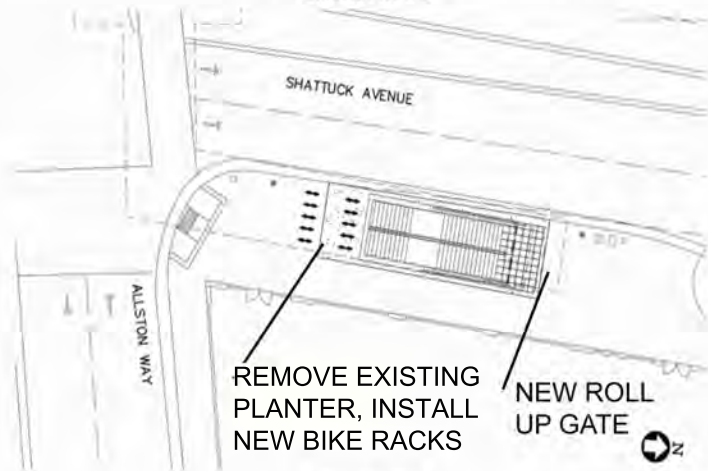

ENTRANCE AREA 2



ENTRANCE AREA 4

DOWNTOWN BERKELEY BART PLAZA AND TRANSIT AREA IMPROVEMENT PROJECT- 65% ILLUSTRATIONS

ENTRANCE 2, 4, 5 AND 6 AREA PLANS

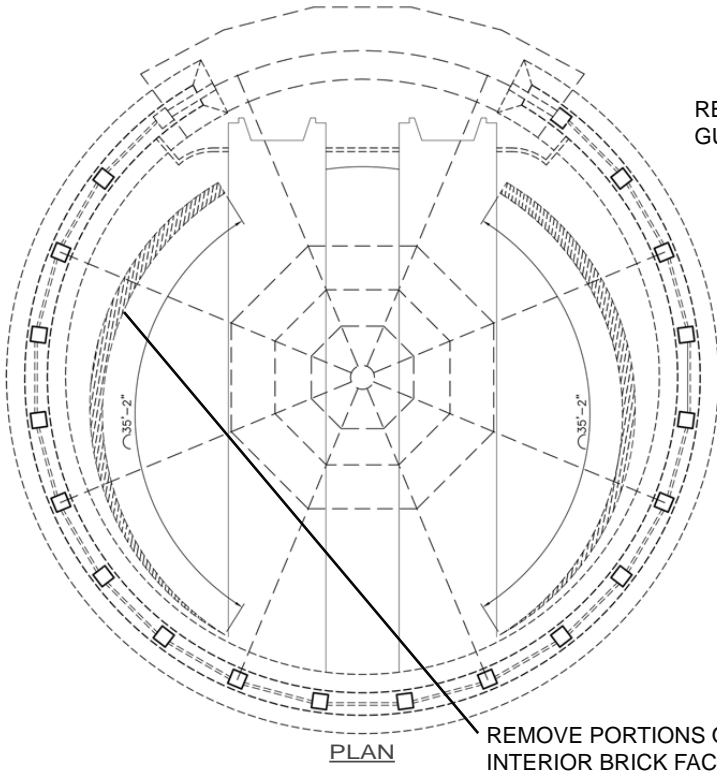

REMOVE EXISTING
GUARDRAILS

REMOVE EXISTING STRUCTURE

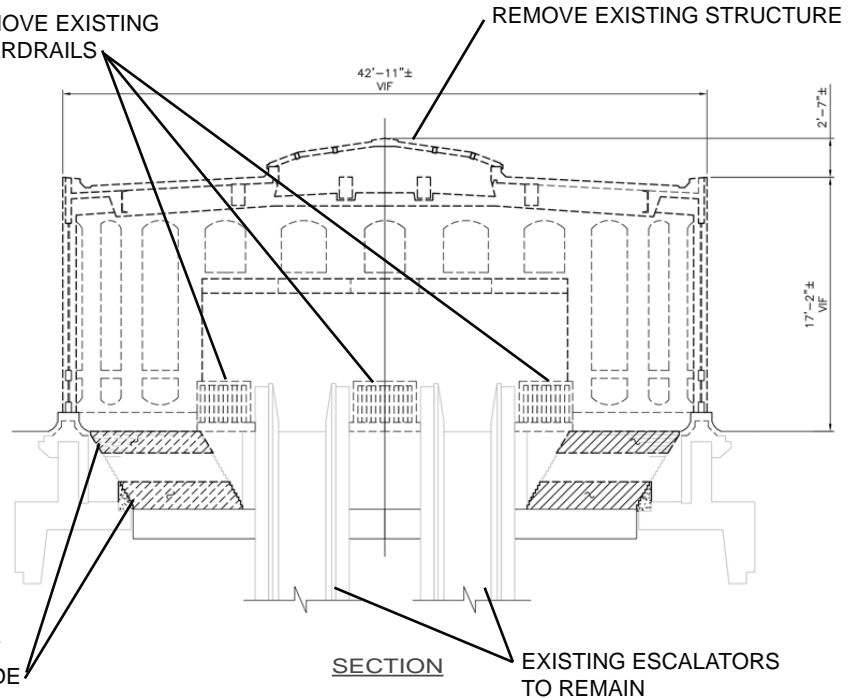

REMOVE PORTIONS OF
INTERIOR BRICK FACADE

SECTION

EXISTING ESCALATORS
TO REMAIN

DOWNTOWN BERKELEY BART PLAZA AND TRANSIT AREA
IMPROVEMENT PROJECT- 65% ILLUSTRATIONS

EXISTING ENTRANCE 3
DEMOLITION PLAN AND SECTION

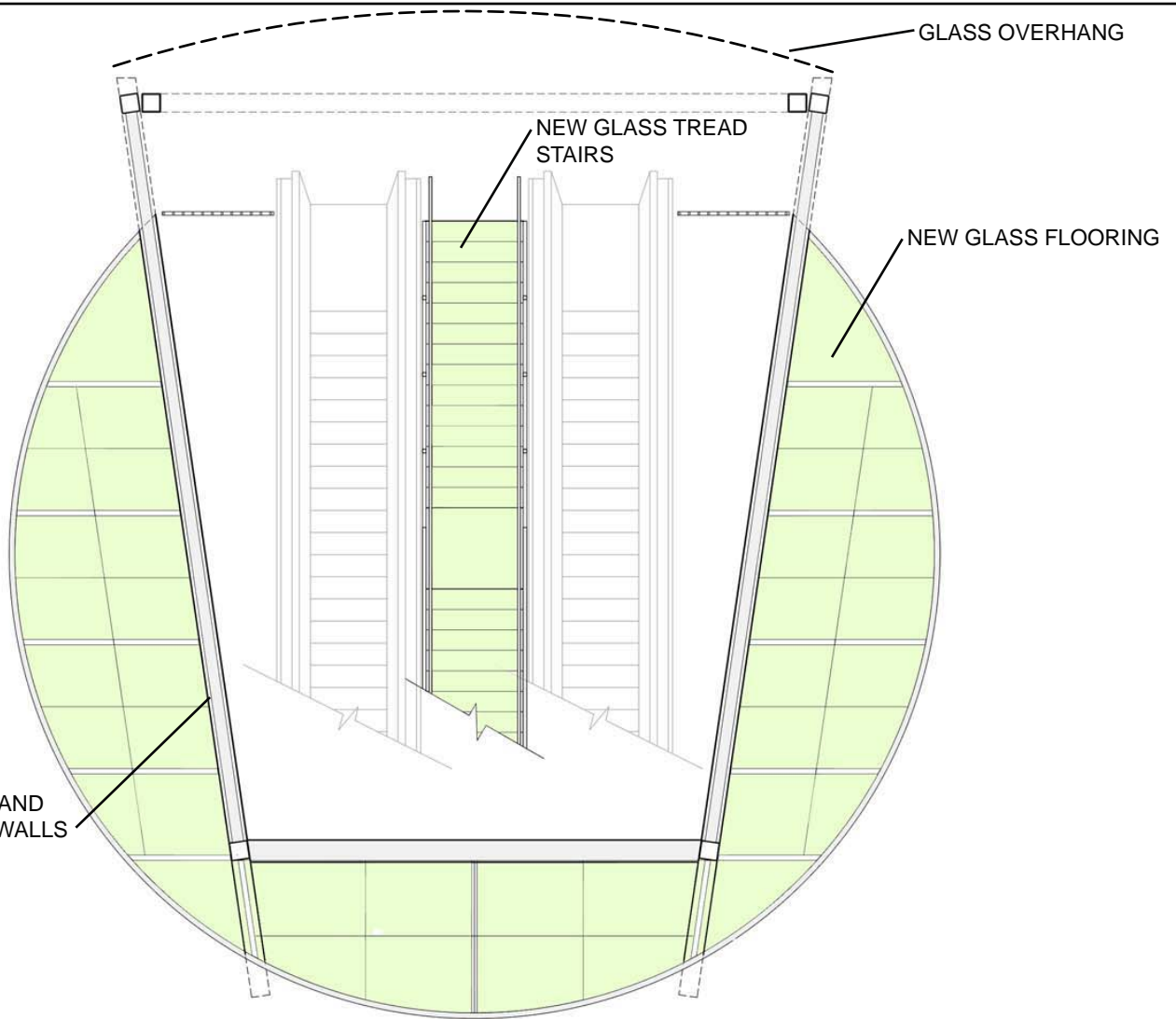

DOWNTOWN BERKELEY BART PLAZA AND TRANSIT AREA
IMPROVEMENT PROJECT- 65% ILLUSTRATIONS

ENTRANCE 3 HEADHOUSE
FLOOR PLAN

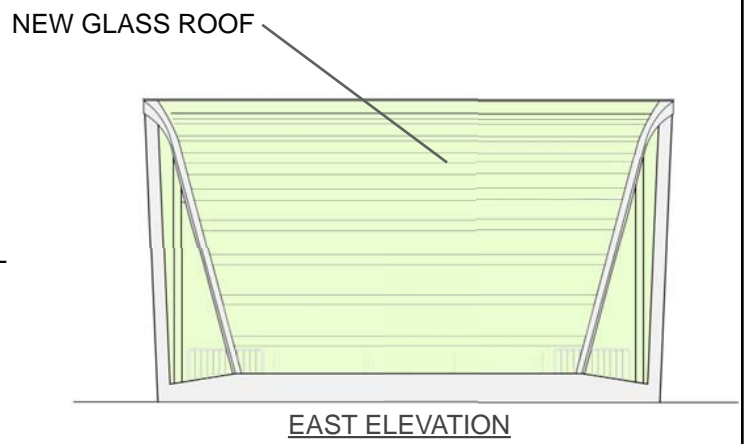
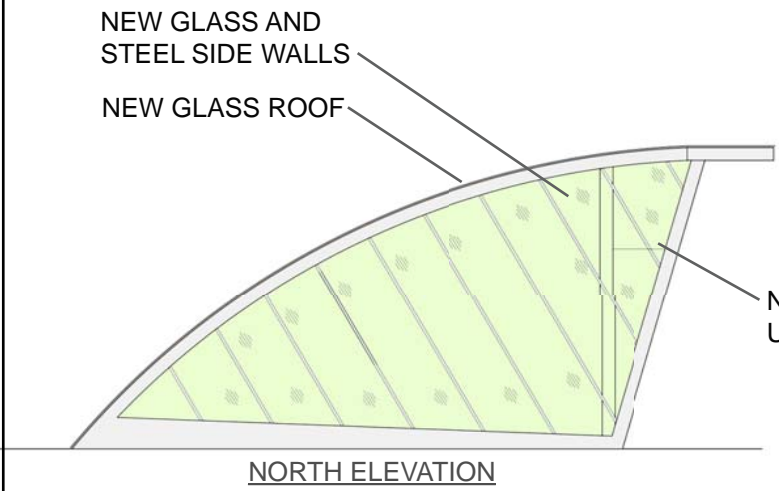
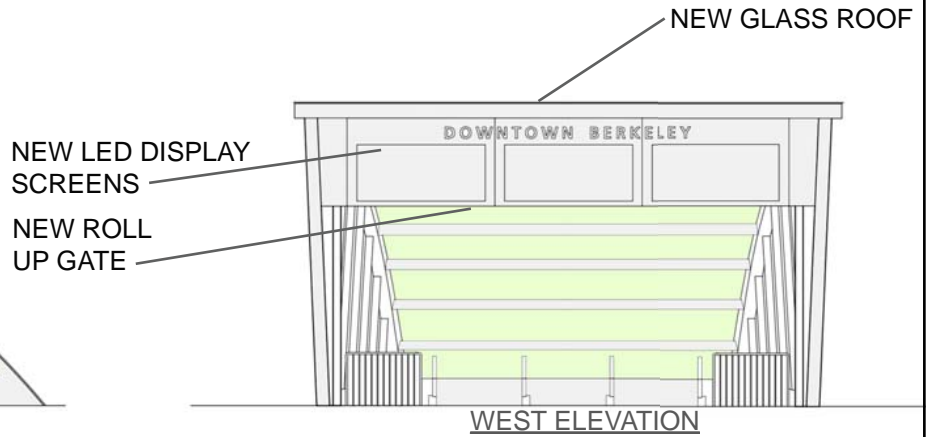
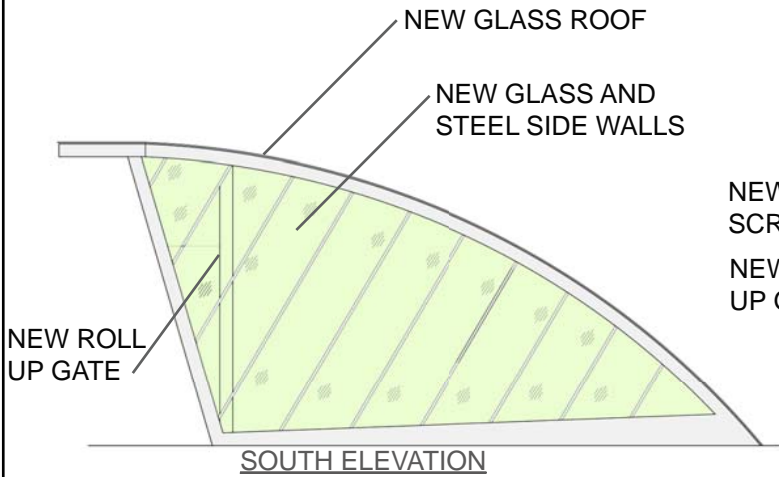

DOWNTOWN BERKELEY BART PLAZA AND TRANSIT AREA
IMPROVEMENT PROJECT- 65% ILLUSTRATIONS

ENTRANCE 3 HEADHOUSE
ELEVATIONS

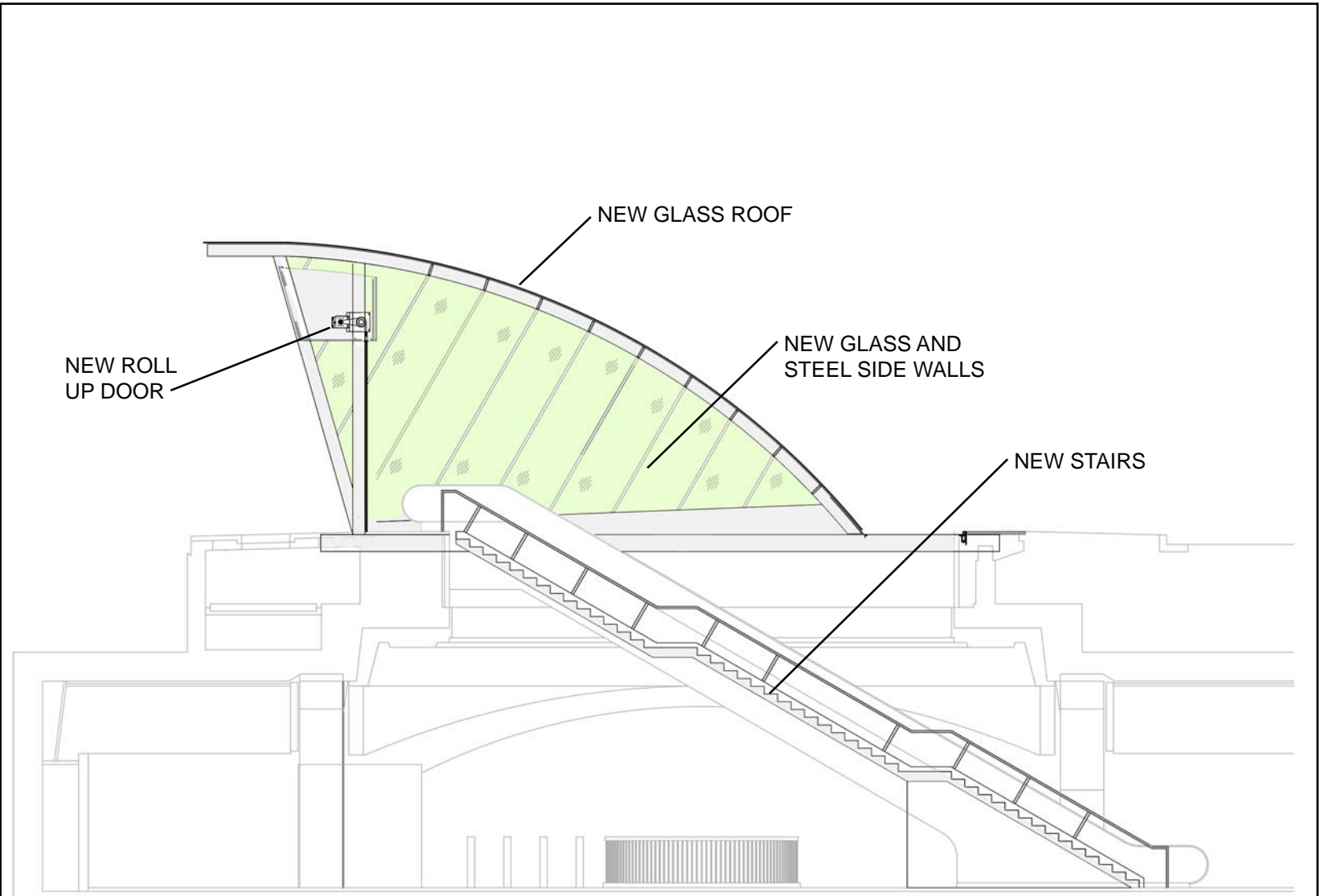

DOWNTOWN BERKELEY BART PLAZA AND TRANSIT AREA
IMPROVEMENT PROJECT- 65% ILLUSTRATIONS

ENTRANCE 3 HEADHOUSE
LONGITUDINAL SECTION

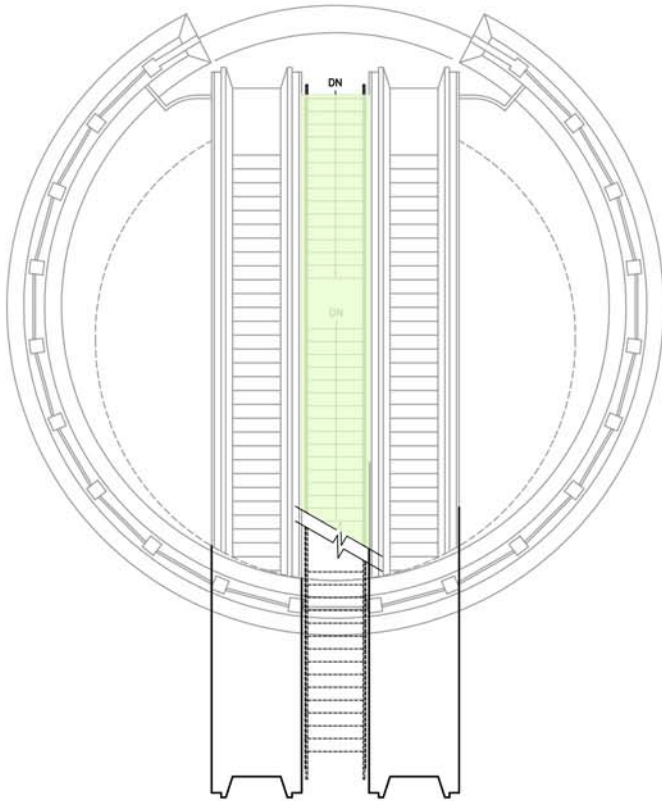

ENTRANCE 3 FLOOR PLAN - PLAZA LEVEL

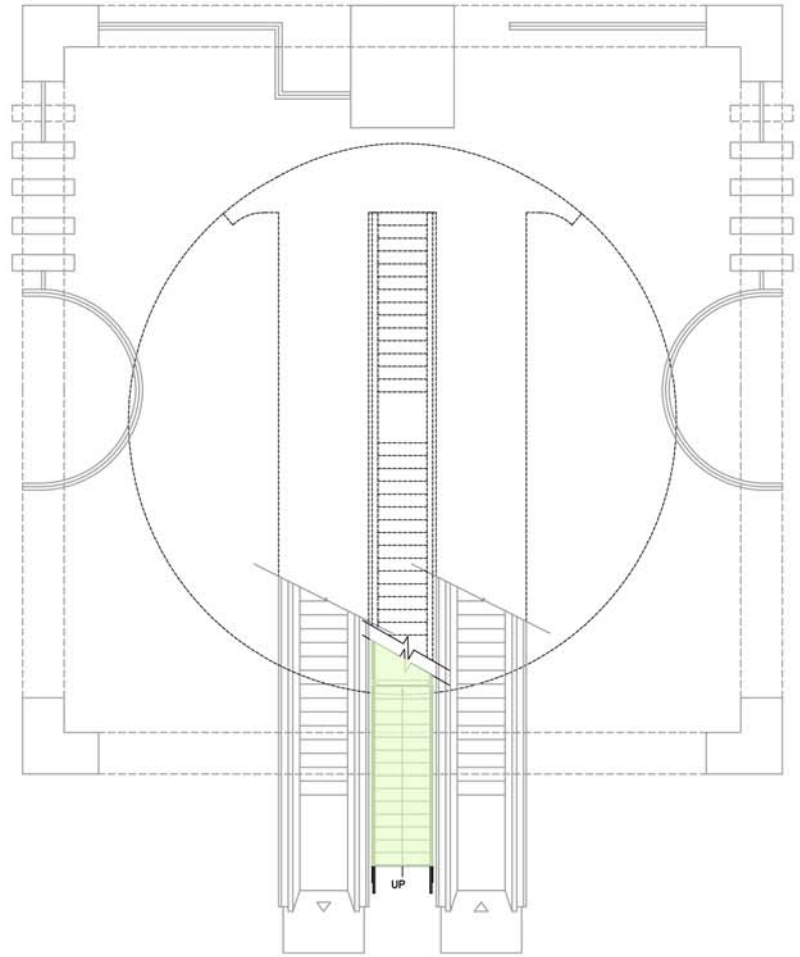

ENTRANCE 3 FLOOR PLAN - CONCOURSE LEVEL

DOWNTOWN BERKELEY BART PLAZA AND TRANSIT AREA
IMPROVEMENT PROJECT- 65% ILLUSTRATIONS

ENTRANCE 3 STAIRS

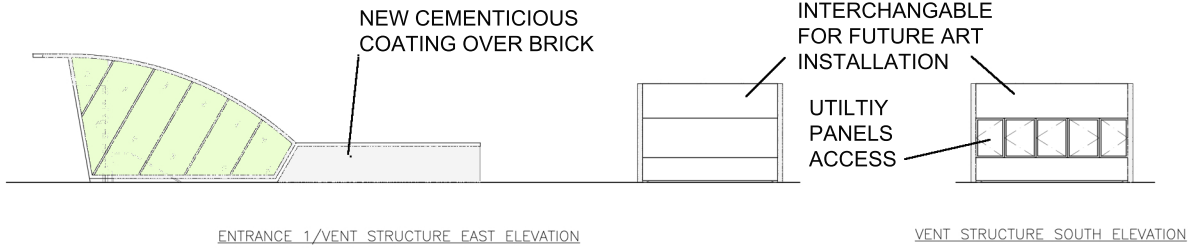
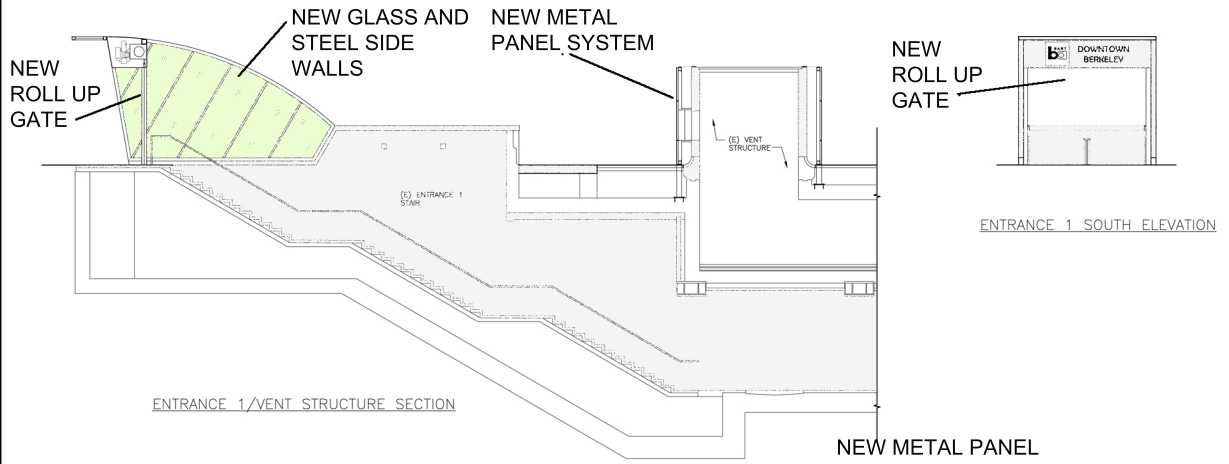

ENTRY STAIR MODIFICATION AT PLAZA

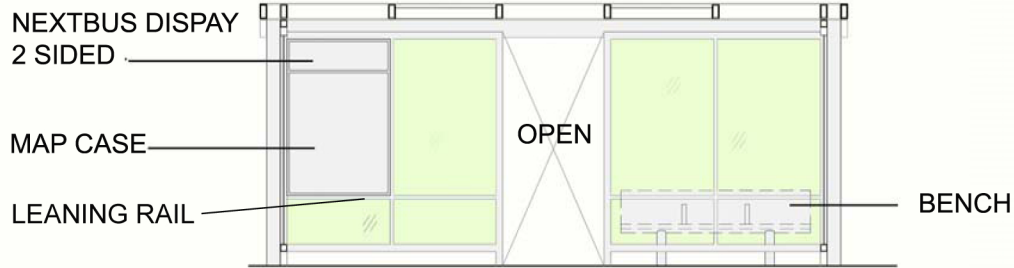

BUS SHELTER SECTION

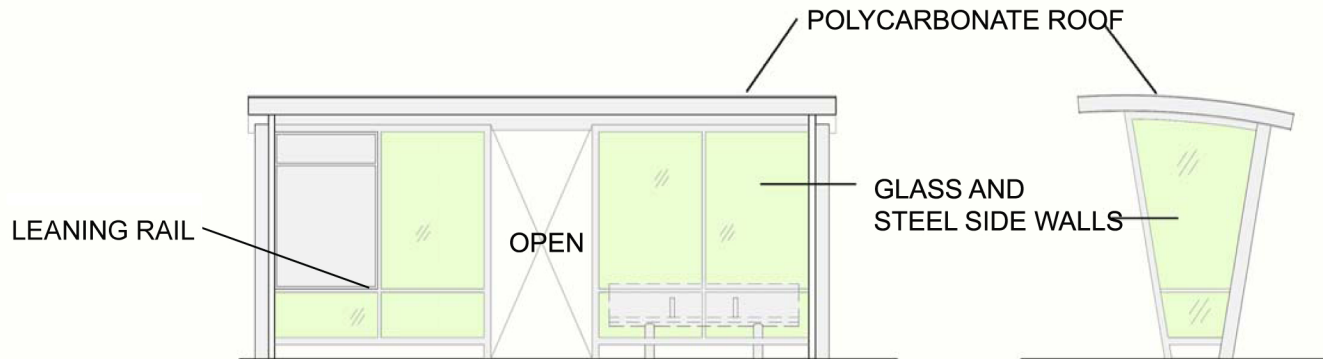

BUS SHELTER WEST ELEVATION

BUS SHELTER NORTH ELEVATION

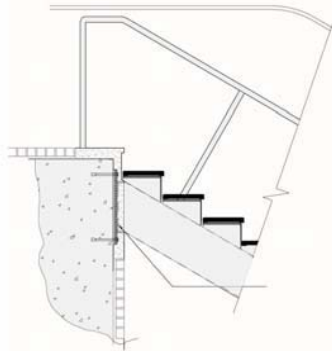

TOP LANDING DETAIL

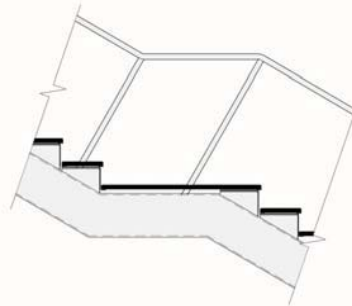

LANDING DETAIL

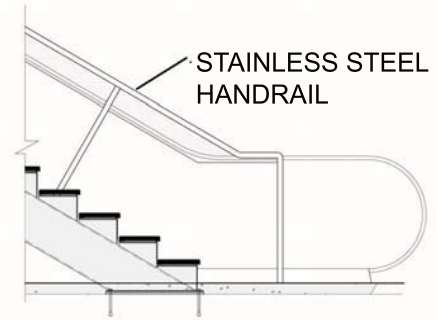

BOTTOM LANDING DETAIL

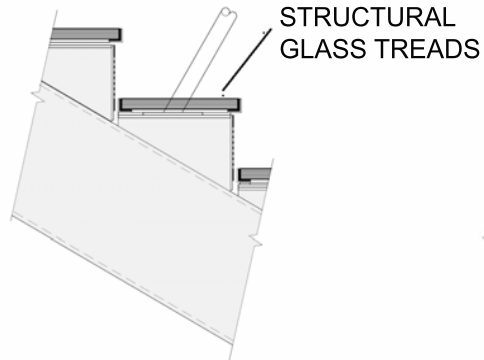

TREAD DETAIL

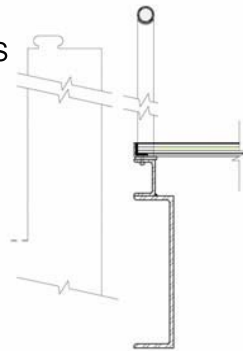

HANDRAIL DETAIL

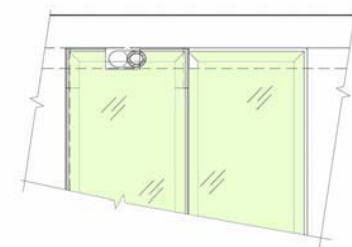

TREAD DETAIL -PLAN VIEW

DOWNTOWN BERKELEY BART PLAZA AND TRANSIT AREA
IMPROVEMENT PROJECT- 65% ILLUSTRATIONS

NEW ENTRY STAIRS AT
ENTRANCE 3 HEADHOUSE

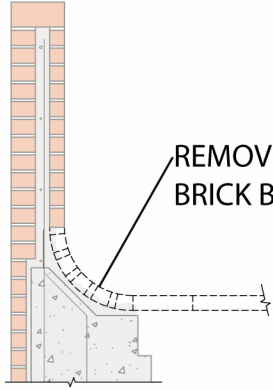

ENTRANCE 1 DEMO DETAIL

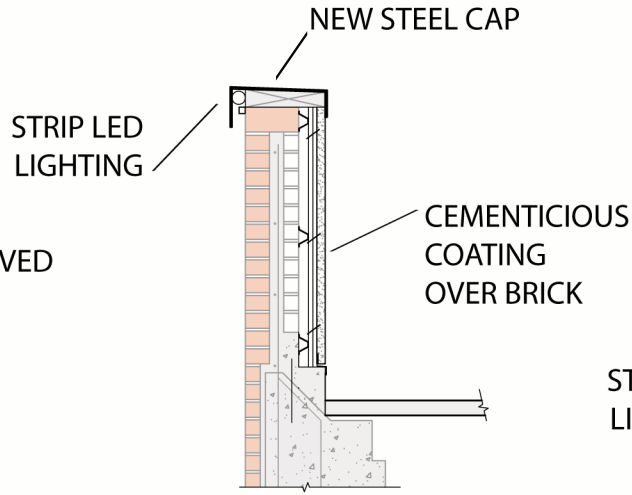

ENTRANCE 1 PARAPET DETAIL

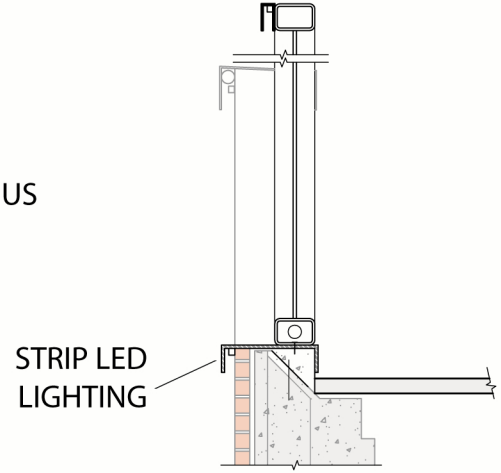

ENTRANCE 1 GLASS SCREEN DETAIL 1

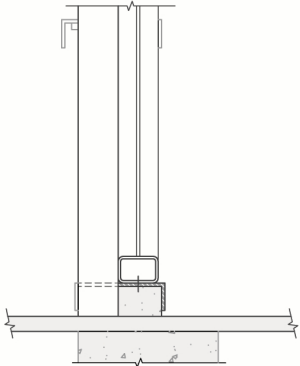

ENTRANCE 1 GLASS SCREEN DETAIL 2

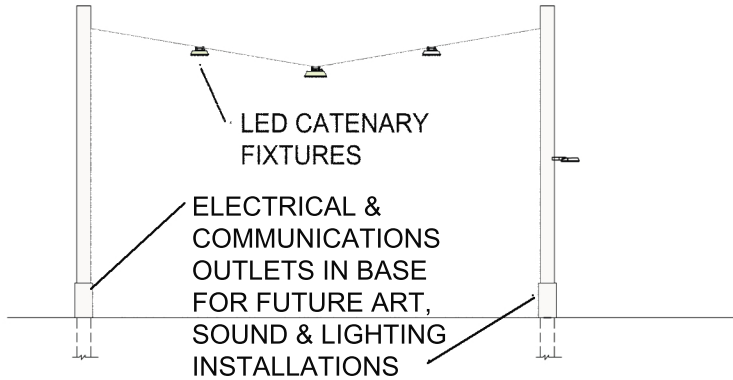

CATENARY AND PEDESTRIAN LIGHTING WIDE SPAN

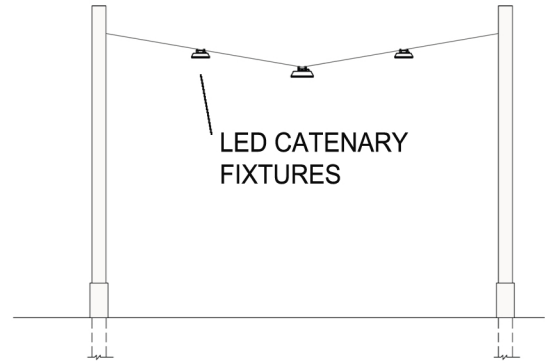

CATENARY AND PEDESTRIAN LIGHTING SHORT SPAN

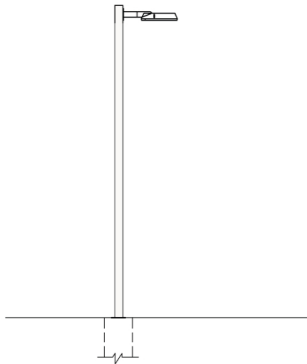

PEDESTRIAN LIGHT F4

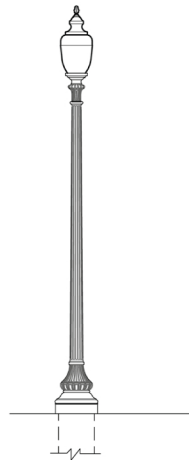

PEDESTRIAN LIGHT F1

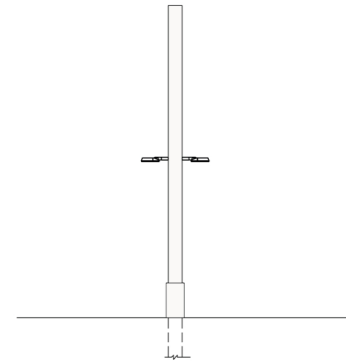

PEDESTRIAN LIGHT F4 POLE MOUNTED

FRONT
ELEVATION

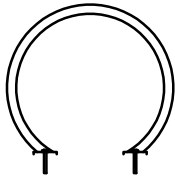

SIDE
ELEVATION

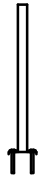

FLANGE
TOP VIEW



BICYCLE RACK DETAIL

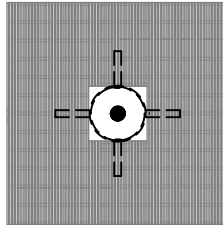

PLAN

TREE GRATE AND FRAME DETAIL



SECTION 'A'



SECTION 'B'

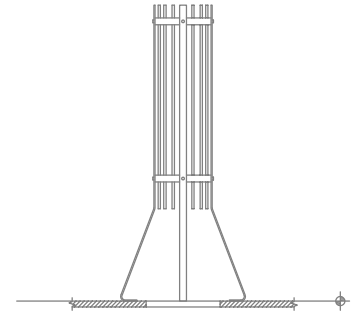

TREE GUARD DETAIL



PLAN VIEW

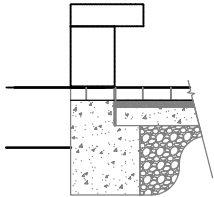

SECTION

SEATING CUBE DETAIL



BASE MOUNTING DETAIL



FRONT

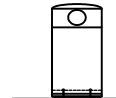

BACK

TRASH/RECYCLING DETAIL

NEW PAVERS

RECESSED PLANTER

RAISED EDGE

BIORETENTION AREA
TO CAPTURE AND
TREAT STORMWATER
RUN OFF

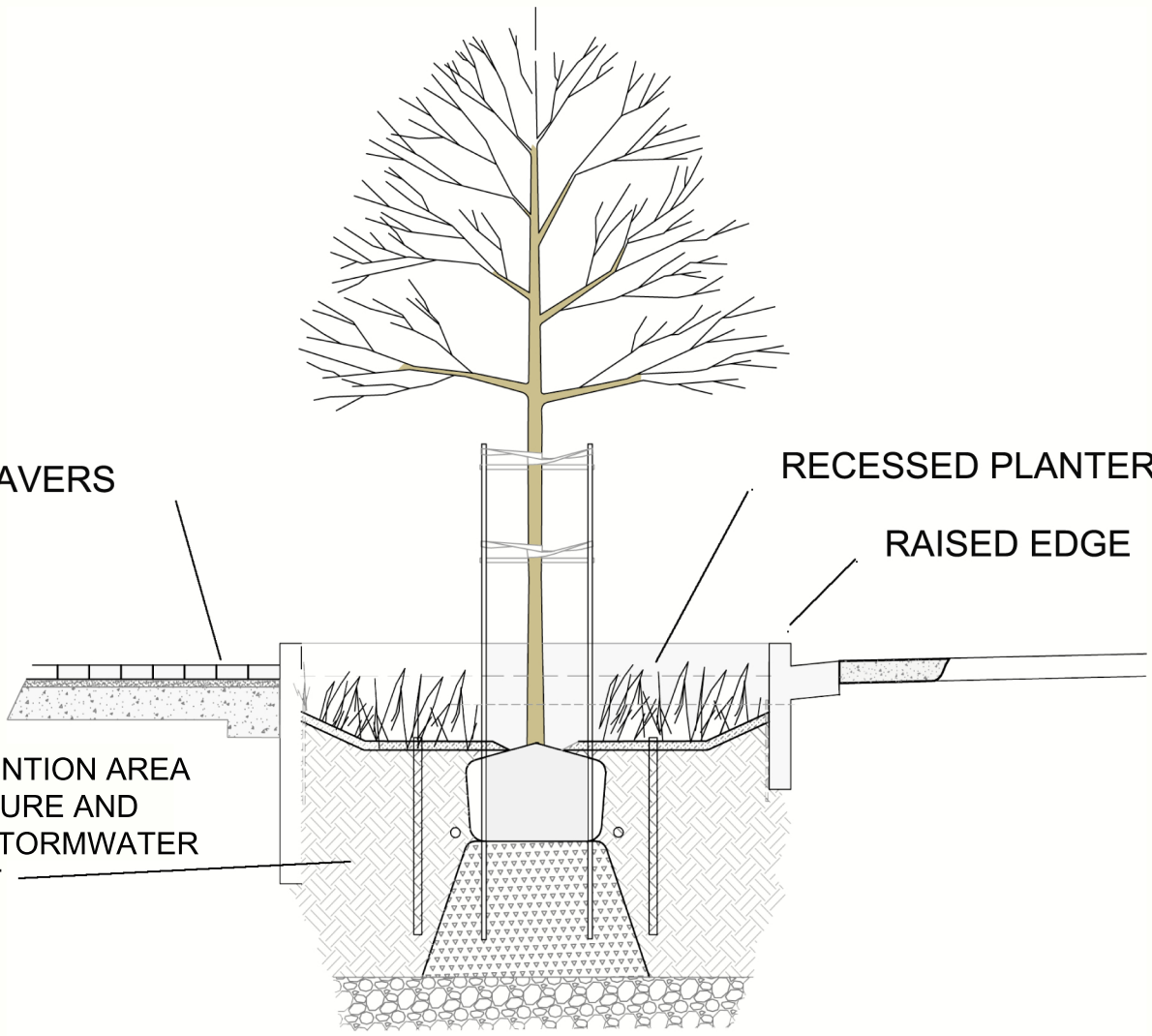

DOWNTOWN BERKELEY BART PLAZA AND TRANSIT AREA
IMPROVEMENT PROJECT- 65% ILLUSTRATIONS

STORMDRAIN /
BIORETENTION DETAIL